

Installationsanleitung FiberDose für FTTH  
Instructions de montage boîtier fibre pour FTTH  
Installation guide FiberOutlet for FTTH

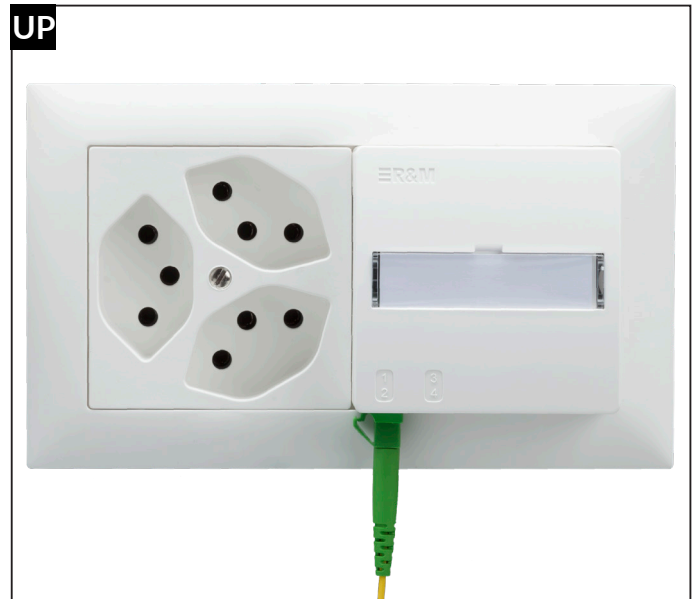

**Ablängen und Spleissen**  
*Découpage et épissage*

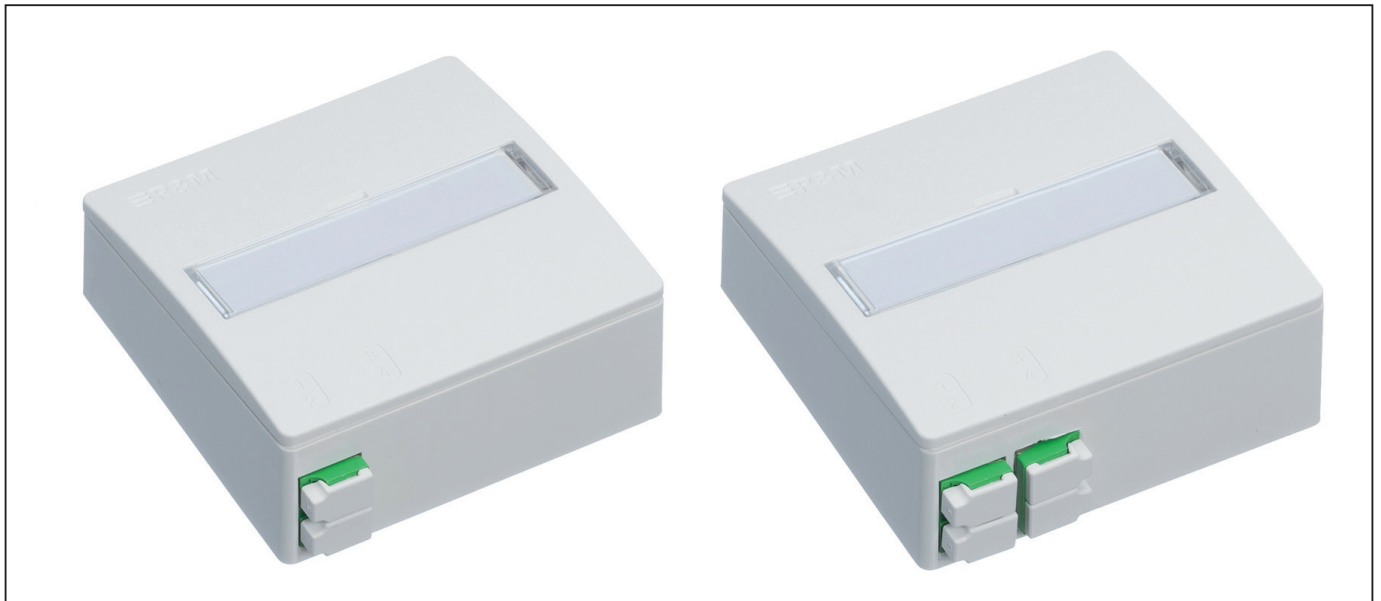
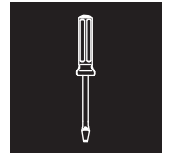
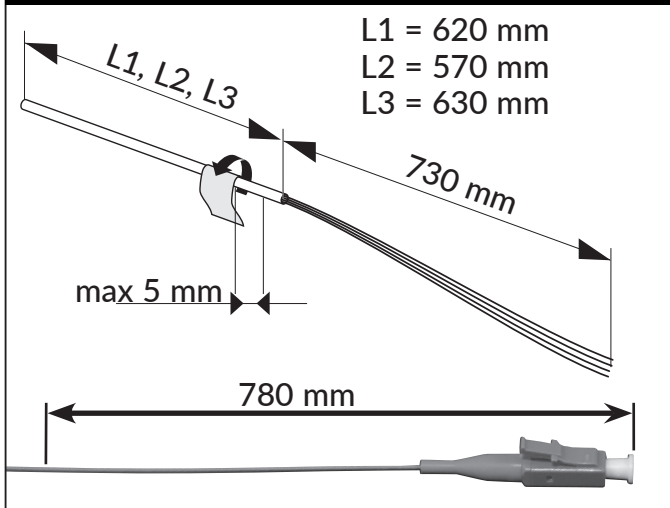

**Faser einlegen**  
*Introduction des fibres*

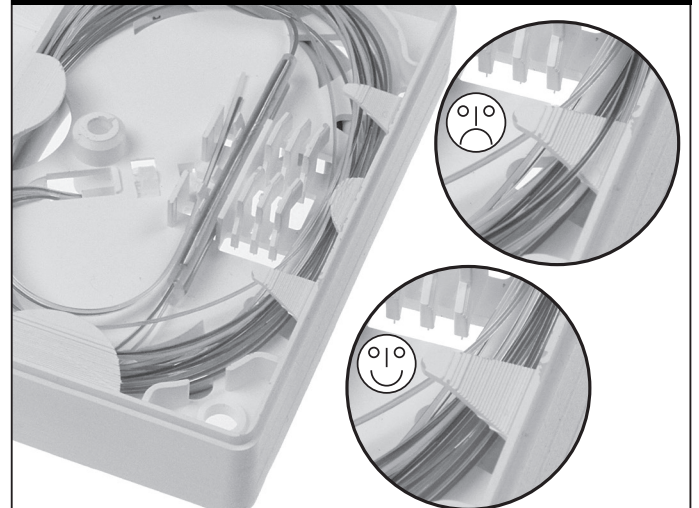

Erweiterung Gr. I zu Gr. II  
Extension de Gr.1 à Gr.2

A



A2

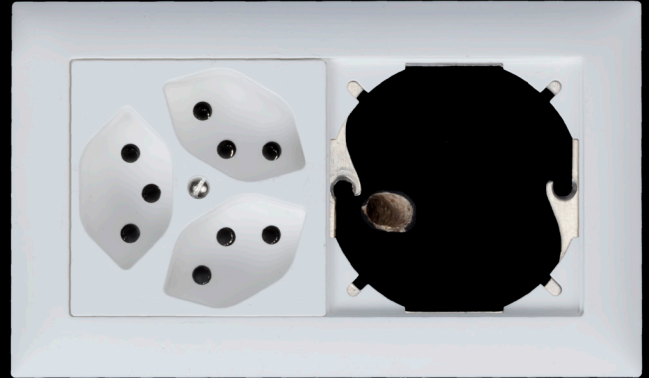

A3



A4

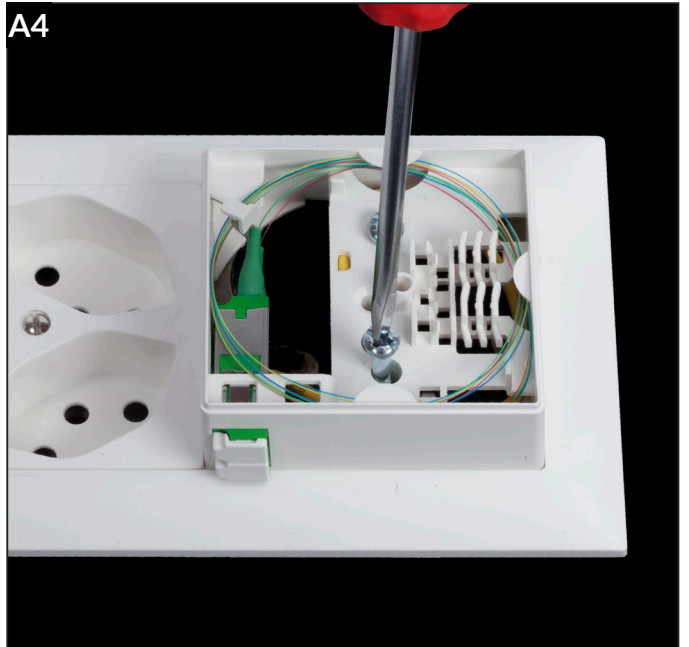

In Kombination / UP Montage  
Combinaison / montage enc.

B

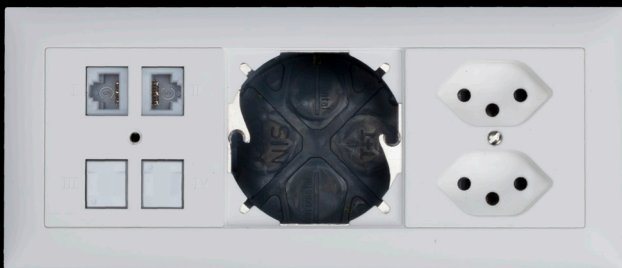

B2

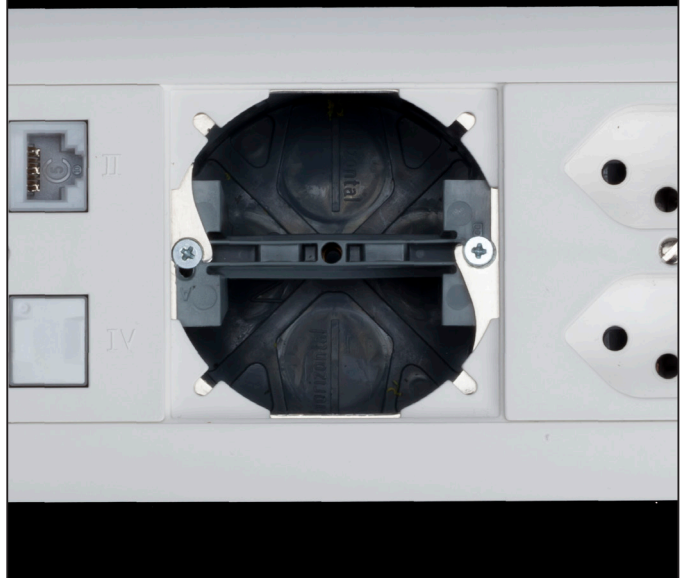

B3



B4

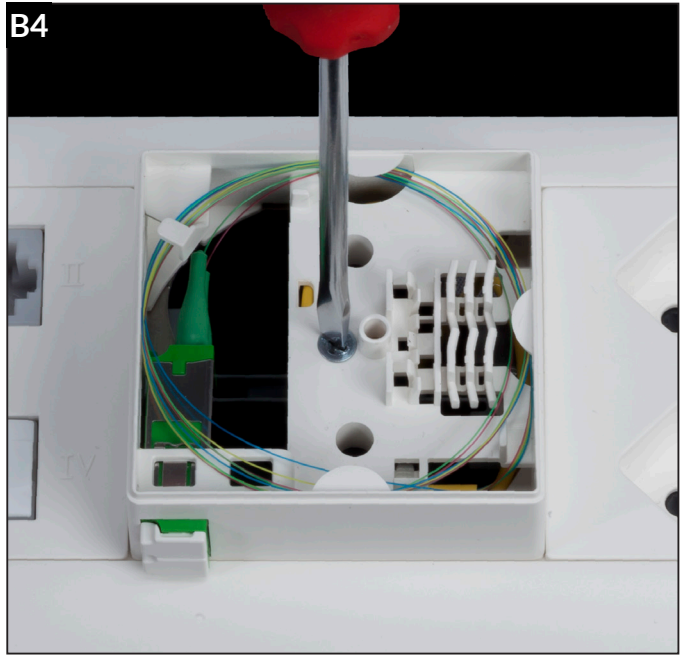

AP Montage  
Montage apparent

C

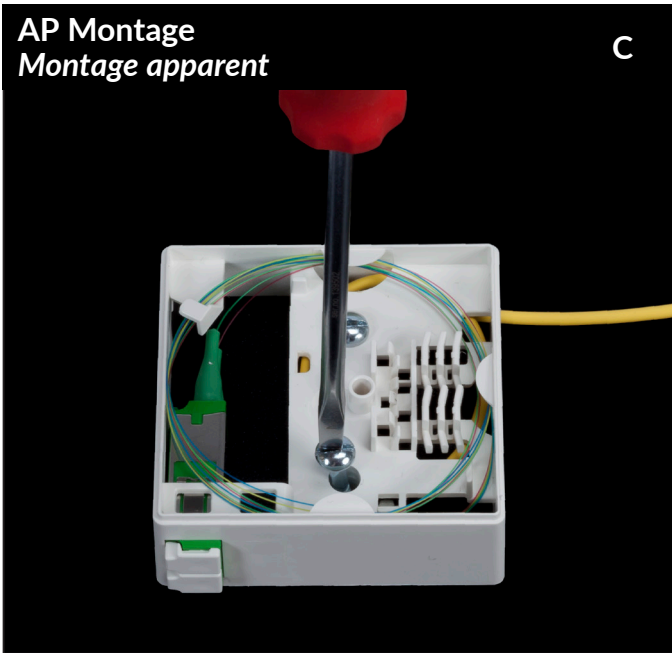

Allgemein Deckelmontage  
Montage du couvercle

D



D2



Erweiterung 1xLC Duplex zu 2xLC Duplex  
Extension de 1x à 2x LC duplex

E

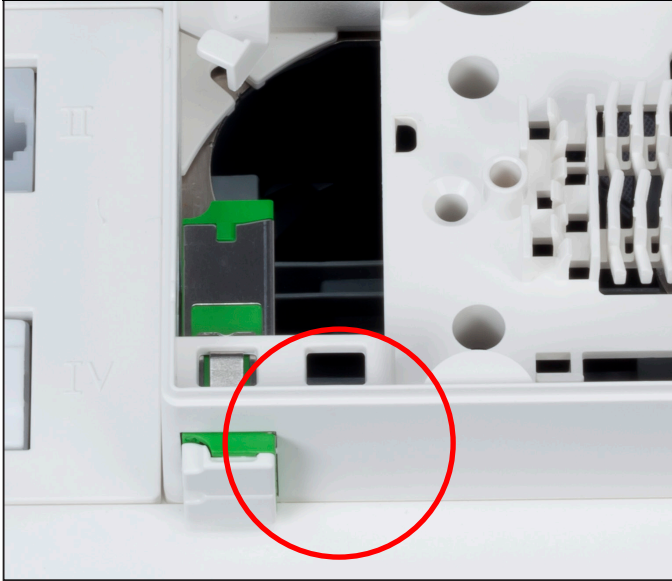

E2

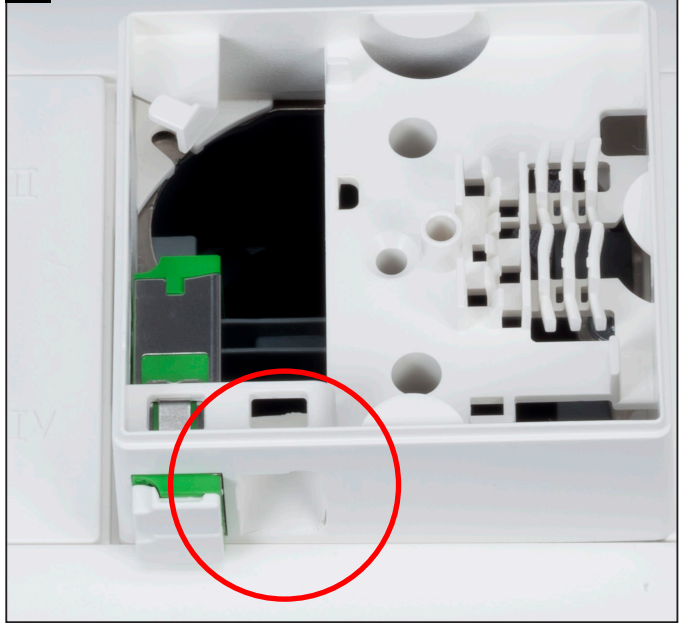

E3

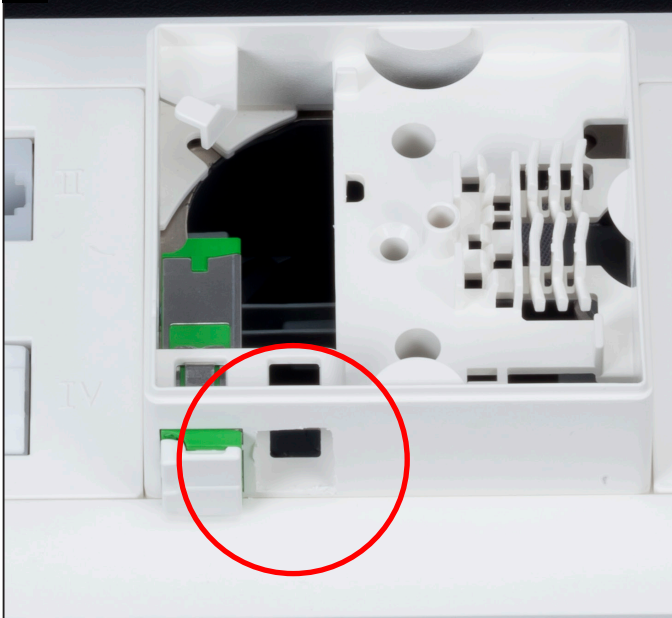

E4

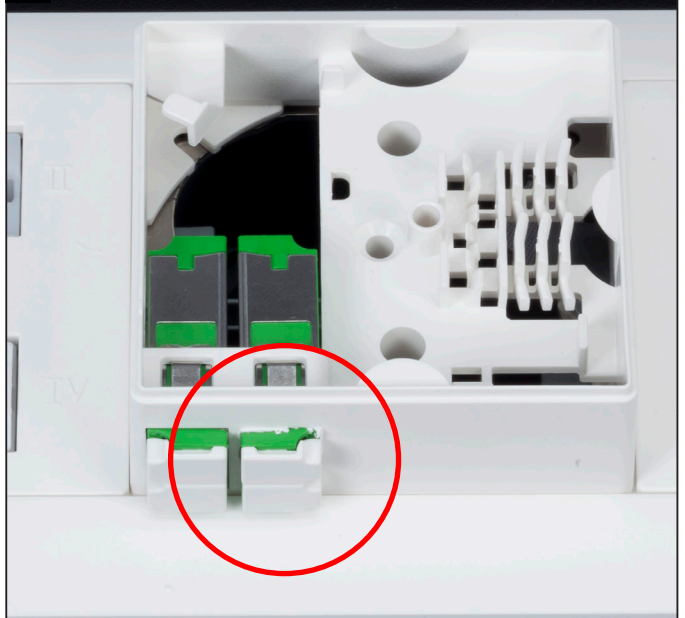

Reichle & De-Massari AG  
Verkauf Schweiz  
Binzstrasse 32  
CHE-8620 Wetzikon  
+41 (0)44 931 97 77  
che@rdm.com  
www.rdm.com

