

Installationsanleitung FiberDose für FTTH
 Instructions de montage boîtier fibre pour FTTH
 Installation guide FiberOutlet for FTTH

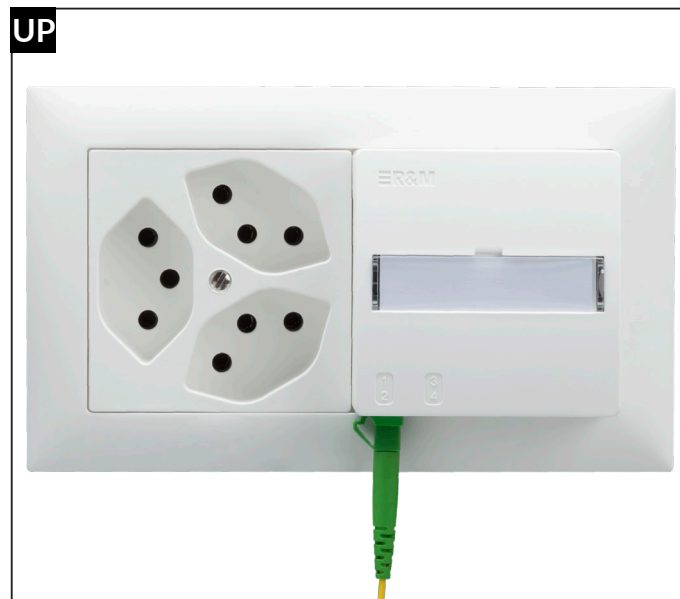

Ablängen und Spleissen
Découpage et épissage

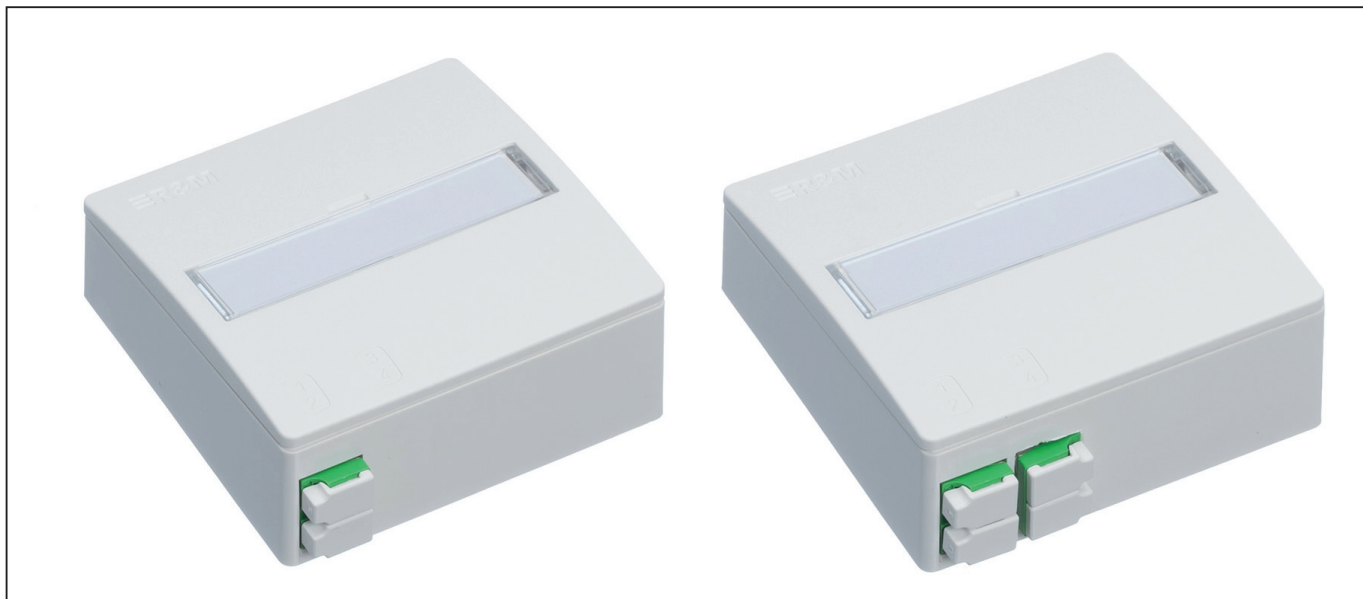
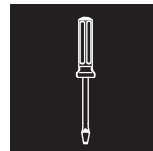
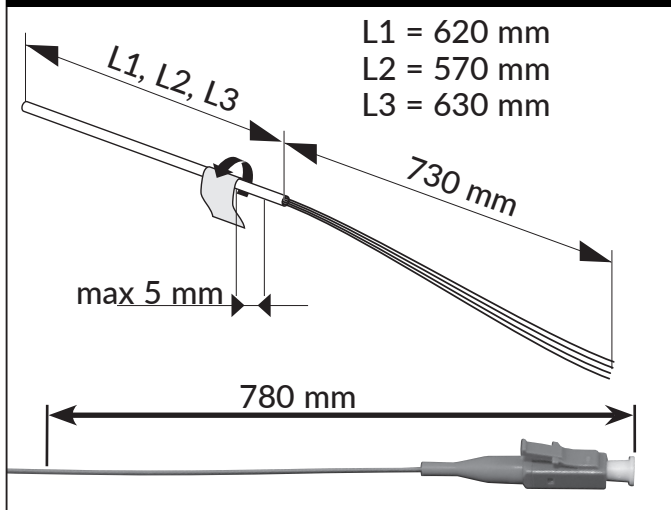

Faser einlegen
Introduction des fibres

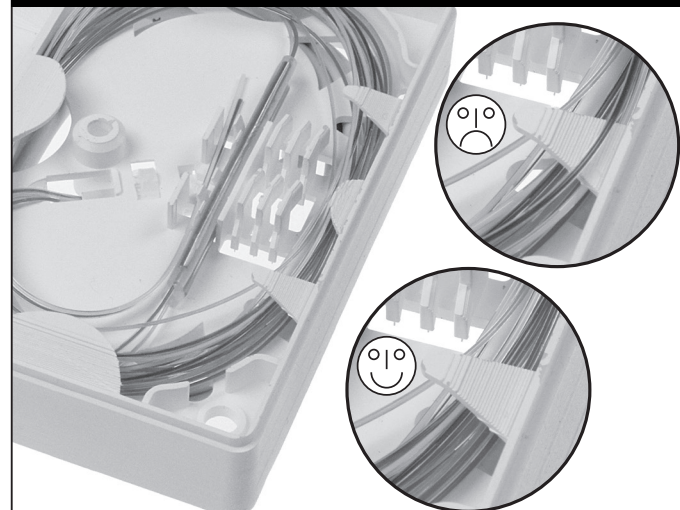

Erweiterung Gr. I zu Gr. II
Extension de Gr.1 à Gr.2

A



A2



A3



A4

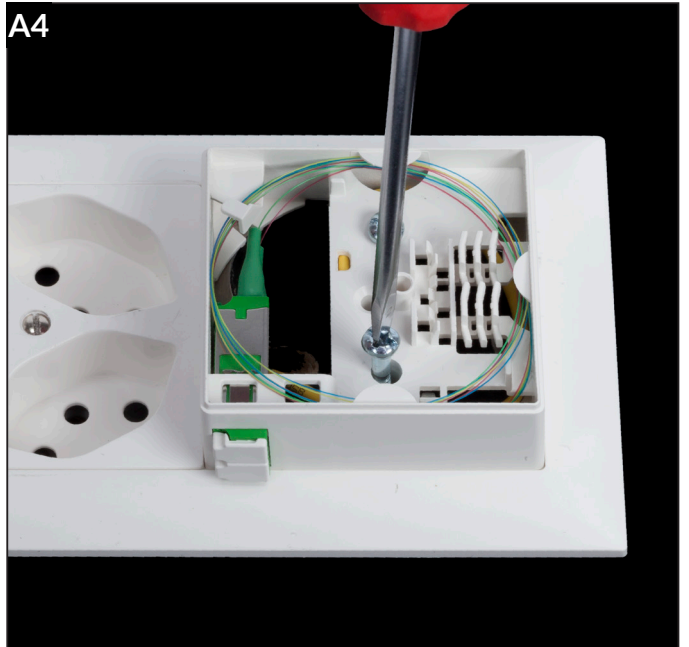

In Kombination / UP Montage
Combinaison / montage enc.

B

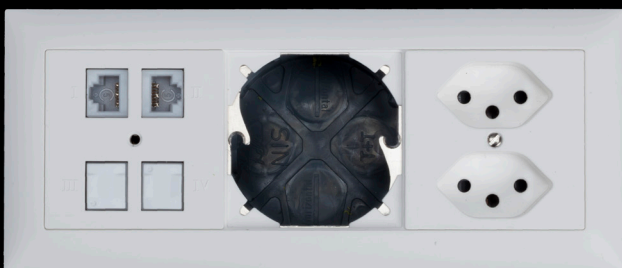

B2

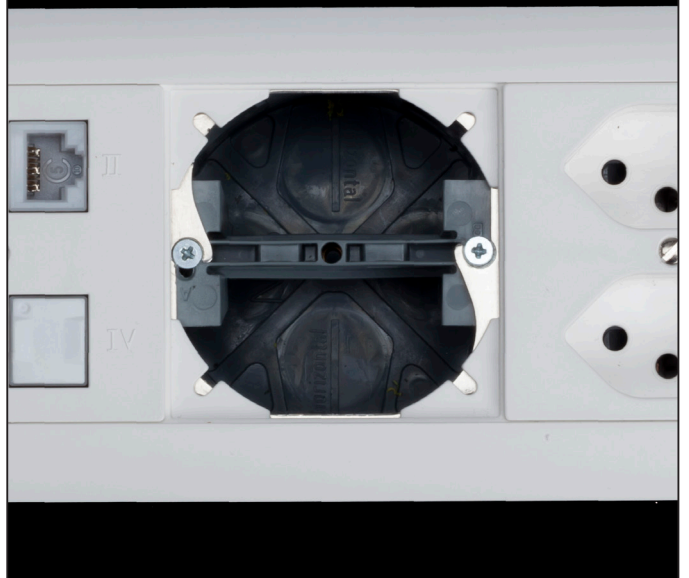

B3



B4

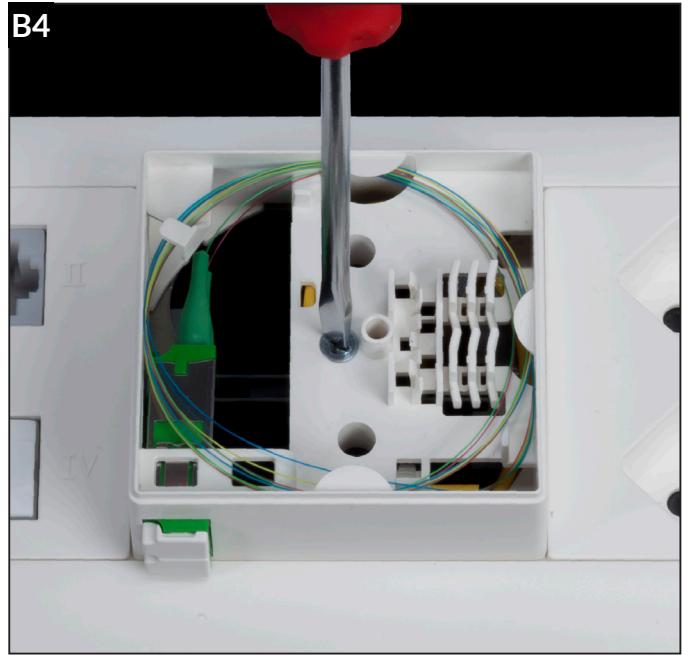

AP Montage
Montage apparent

C

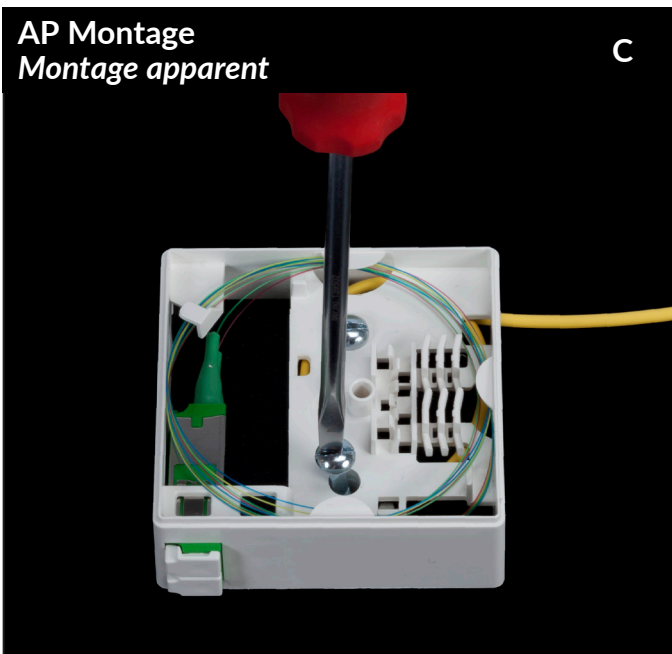

Allgemein Deckelmontage
Montage du couvercle

D

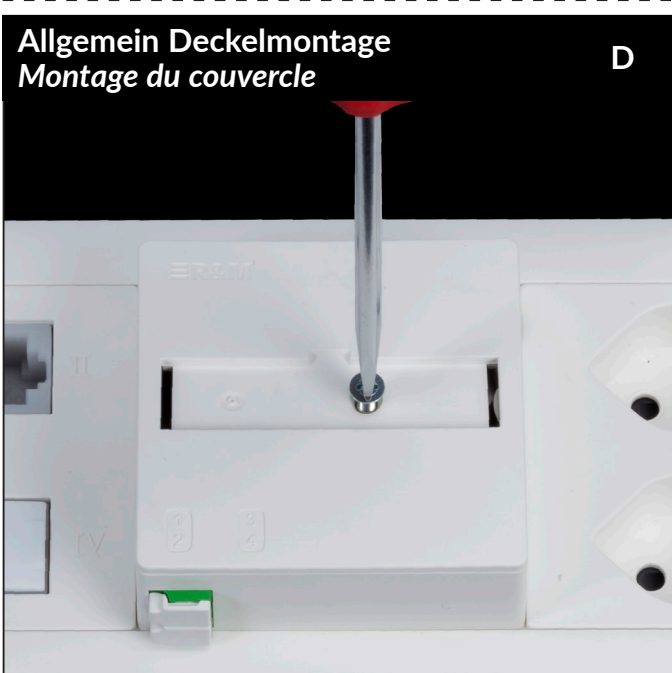

D2



Erweiterung 1xLC Duplex zu 2xLC Duplex
Extension de 1x à 2x LC duplex

E

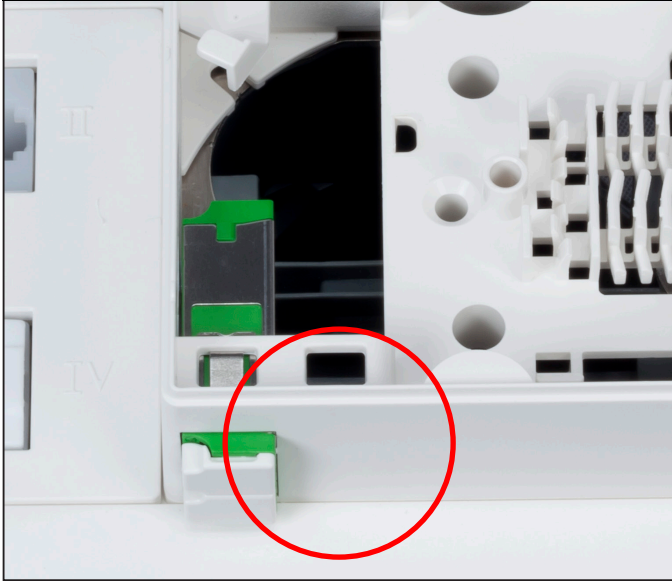

E2

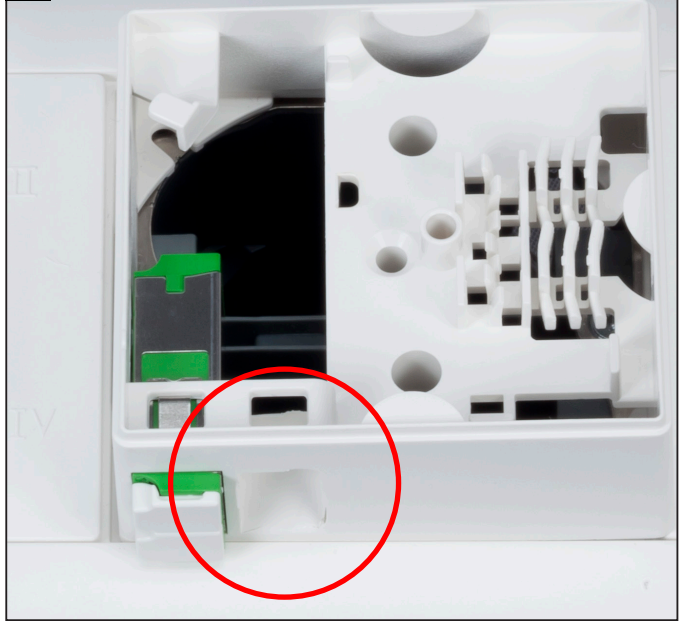

E3

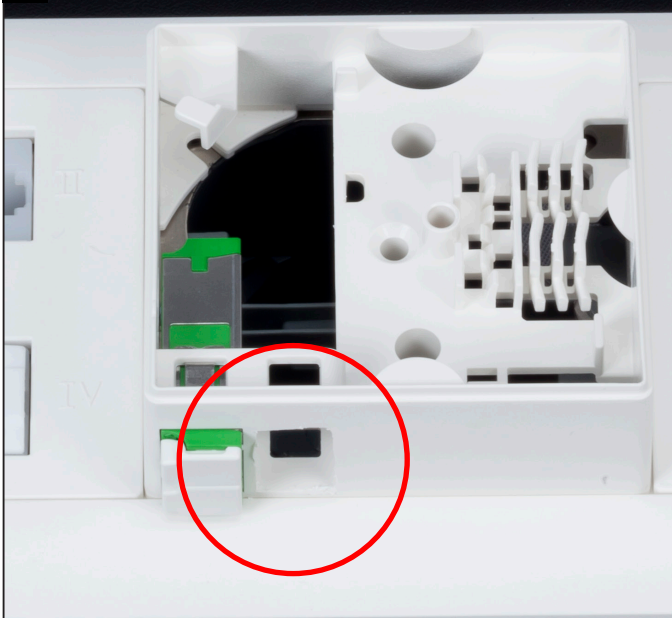

E4

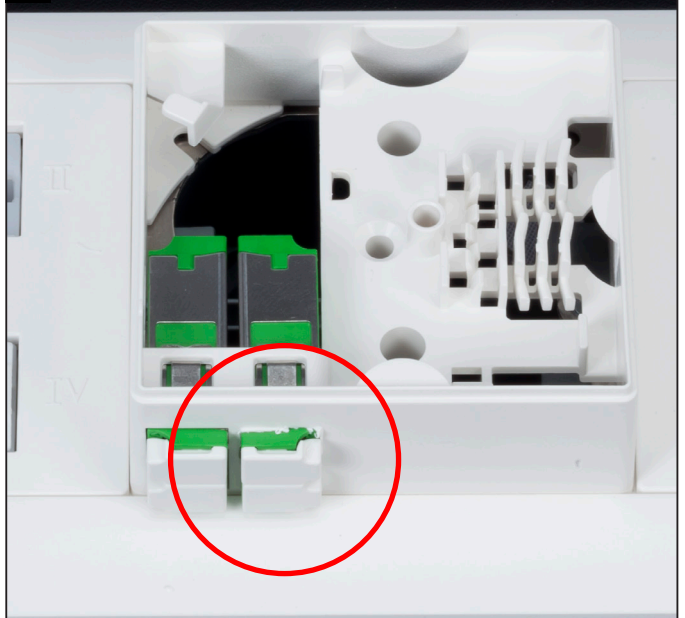

Reichle & De-Massari AG
Verkauf Schweiz
Binzstrasse 32
CHE-8620 Wetzikon
+41 (0)44 931 97 77
che@rdm.com
www.rdm.com

